

3-POINT CARGO BOX YARD TOOL HOLDER ASSEMBLY

CB-ACC-YT-AC

TOOLS REQUIRED



7/16" & 1/2"
SOCKET WRENCH



1/8" HEX WRENCH

FOR USE WITH THE VALLEY INDUSTRIES HEAVY HAULER™ 3-POINT UTILITY CARGO BOX

INCLUDED COMPONENTS



Steel Posts (2)
31-300079 (L) & 31-300080 (R)

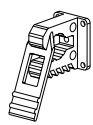

Small Quick Grip Fists (8)
33-300109

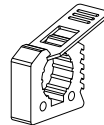

Large Quick Grip Fists (2)
33-300108



1" Hex Screws (10)
33-200030



Flat Washers (10)
33-103131

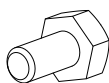

1/2" Bolts (8)
33-103148



1/4" Serrated Flange Nuts (8)
33-103149



Nylock Nut (10)
33-300105

YARD TOOL HOLDER ASSEMBLY

1.

PARTS

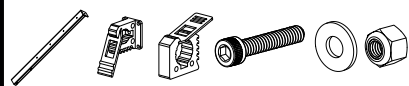

TOOLS

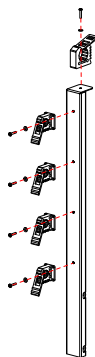

With a 1/8" Hex Wrench, install a Large Quick Grip Fist on the top and 4 Small Quick Grip Fists on the front of the Steel Post with 1" Screws, Nylock Nuts and Flat Washers.

Repeat step for the remaining Steel Post.

Attaches Quick Fist Holders to Posts

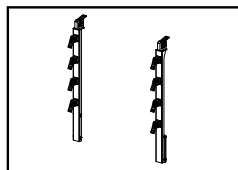

2.

PARTS



TOOLS



Line up bottom holes of Steel Post with holes on hitch side of 3-Point Cargo Box. Insert 1/2" Bolts.

Thread the 1/4" Serrated Flange Nut onto 1/2" Bolt. Tighten with 7/16" Socket Wrench.

Repeat step for the remaining Steel Post.

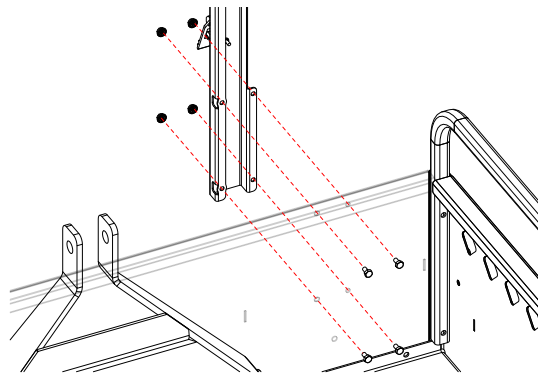

Attaches Posts to Cargo Box

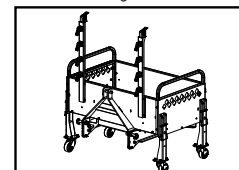

HAVING TROUBLE? CALL THE SUPPORT TEAM AT: 800.864.1649

WARRANTY

The Heavy Hauler 3-Point Cargo Box Yard Tool Holders manufactured by Valley Industries are warranted for 1-year from date of shipment when properly assembled, installed, maintained, and operated. The warranty will cover only manufacturer and workmanship defects.

Valley Industries will not be liable for any consequential, incidental, or indirect damages from any cause whatsoever.

Not Covered Under Warranty:

- Normal wear and tear that have been subjected to accident, abuse, misapplication, improper assembly, improper installation or improper maintenance.
- Components and equipment not manufactured by Valley Industries.

OTHER ACCESSORIES

**SOLD
SEPARATELY** ▼

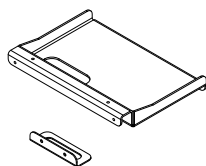

Chainsaw Holder
CB-ACC-SH



Layer Rails
CB-ACC-LR

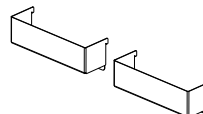

Front Storage Pockets
CB-ACC-FP

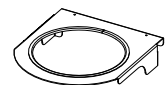

5 Gallon Pail Holder
CB-ACC-PH

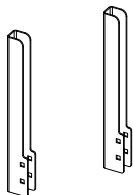

Load Extension Bars
CB-ACC-EB

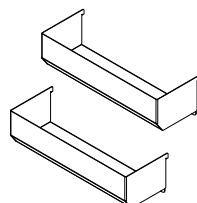

Side Storage Pockets
CB-ACC-SP

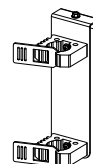

Single Large Yard Tool Holder
CB-ACC-LY

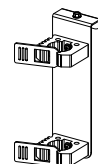

Single Small Yard Tool Holder
CB-ACC-SY